



NarrowDIM X4

4-Channel Universal Light Dimmer

ZDINDX4

Application program version: [1.2]

User manual edition: [1.2]_a

www.zennio.com

CONTENTS

Contents	2
Document updates.....	3
1 Introduction	4
1.1 NarrowDIM X4.....	4
1.2 Load Types.....	6
1.2.1 Combining Load Types.....	6
1.3 Installation.....	8
2 Configuration	9
2.1 General.....	9
2.2 Channel Cx / Channel Cx + Cy / Channel C1 + C2 + C3 + C4	13
2.2.1 Dimming	13
2.2.2 Configuration.....	19
2.3 Error Notifications.....	35
2.3.1 Bus Notifications.....	35
2.3.2 LED Indicators.....	35
2.3.3 Reaction to Errors.....	37
2.4 Logic Functions.....	41
2.5 Manual Control	42
2.5.1 Test On Mode	43
2.5.2 Test Off Mode.....	43
ANNEX I: Communication Objects	44

DOCUMENT UPDATES

Version	Changes	Page(s)
[1.2]_a	Changes in the application program: <ul style="list-style-type: none"><li data-bbox="454 456 775 488">• Internal optimisation.	-

1 INTRODUCTION

1.1 NarrowDIM X4

NarrowDIM X4 is a **four-channel** multi-function KNX light dimmer from Zennio. Its wide variety of functions make it versatile and robust device.

- Compatibility with **resistive (R)**, **inductive (L)**, **capacitive (C)**, **LED*** and low-consumption **CFL*** loads.

(*) Only dimnable LED / CFL lamps are supported.

- **High-performance regulation:** the device is entirely powered from the KNX bus, which prevents limitations and other effects over the load power.
- Automatic **frequency detection**.
- Possibility of automatic load type **detection** for conventional lamps (R / C / L).
- Compatibility with **Uninterruptible Power Supply** systems (UPS).
- Customisable **dimming pattern** for LED and CFL loads.
- Customisable **dimming times**.
- **Individual** or **joint** control of the four output channels.
- **Additional functions:** timed actions, scenes, custom On/Off controls, automatic switch-off, sequences, economy mode, channel lock...
- **Manual operation and supervision** of the loads through the on-board pushbuttons.
- 10 customisable, multi-operation **logic functions**.
- Automatic **error management** (short-circuits, overheating, anomalous network frequencies, overvoltage, absence of power supply and wrong load type selection).
- **LED indicators** to show error situations.

- Data storage and load switch-off on **bus power losses**.
- **Heartbeat** or periodic “still-alive” notification.

1.2 LOAD TYPES

NarrowDIM X4 supports the following load types:

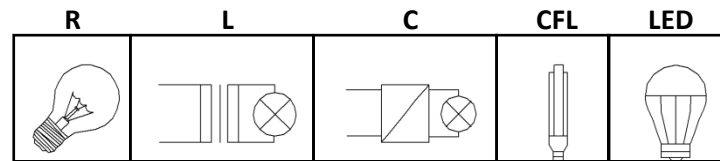

Figure 1 Load Types.

- **Conventional lamps:**
 - Resistive (R),
 - Inductive (L),
 - Capacitive (C),
- Dimmable low-consumption **Compact Fluorescent Lamps (CFL)**.
- Dimmable Light Emitting Diode (**LED**) lamps.

1.2.1 COMBINING LOAD TYPES

In some cases, it is possible to combine different load types in the same channel (i.e., it is possible to control loads of different types together) as long as the following restrictions are satisfied:

- Inductive (L) and resistive (R) loads **can** be combined if the resistive load is less than 50% of the total load.
- Capacitive (C) and resistive (R) loads **can** be combined if the resistive load is less than 50% of the total load.
- Capacitive (C) and inductive (L) loads **cannot** be combined.
- CFL and LED loads **cannot** be combined.
- CFL and conventional (R / L / C) loads **cannot** be combined.
- LED and conventional (R / L / C) loads **cannot** be combined.

- It is advisable **not to combine** different CFL (or LED) loads together in the same channel, as the response may differ depending on the model or maker.

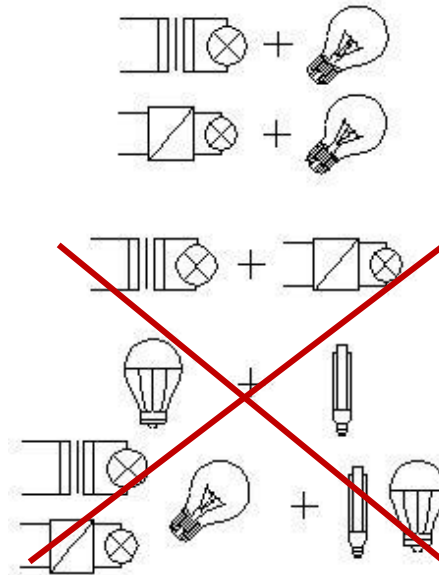

Figure 2. Combining Load Types.

To get further information, please refer to the corresponding **Datasheet**, bundled with the original package of the device and also available at www.zennio.com.

1.3 INSTALLATION

NarrowDIM X4 connects to the KNX bus through the on-board KNX connector. Once the device is provided with power from the KNX bus, both the individual address and the associated application program can be downloaded.

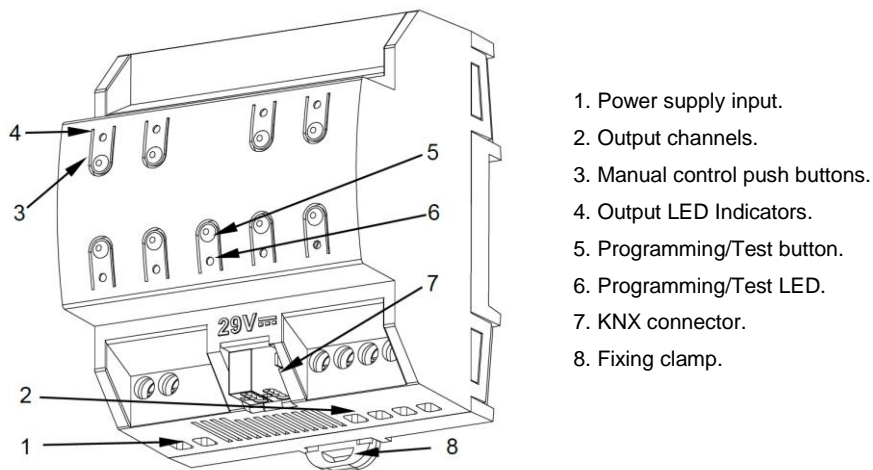

Figure 3 Element Diagram.

The main elements of the device are described next:

- **Test/Prog. Pushbutton (5):** a short press on this button sets the device into the programming mode, making the associated LED (6) light in red.

Note: if this button is held while plugging the device into the KNX bus, the device will enter into **safe mode**. The LED will blink in red every 0.5 seconds.

- **Output Channels (2):** slots for the connection of the output lines (loads).
- **Neutral and Phase Inputs (1):** slots for the connection of the voltage wires (neutral and phase lines).

To get detailed information about the technical features of the device, as well as on the installation and security procedures, please refer to the corresponding **Datasheet**, bundled with the original package of the device and also available at www.zennio.com.

2 CONFIGURATION

2.1 GENERAL

The general configuration of NarrowDIM X4 requires setting some general parameters common to all output channels:

- Whether to control the channels **independently or jointly**.
- The length of the dimming course for the two **Smooth Dimming** functions, which make it possible to increase or decrease the light level of the loads progressively (in contrast to **At Once**). This length is defined as the time for an entire regulation, from a level of 0% (no light) to a level of 100% (full light).

***Note:** there are several ways of regulating the light level. Therefore, it will be necessary to set which cases should do it at once and which ones smoothly.*
- The **manual control** type, in the case that operating the channels through the on-board pushbuttons is necessary for testing or for other purposes.
- Whether to send **error notifications** or not to the bus.
- Enabling or disabling the **Logic Functions** module.
- **Heartbeat** or periodic “still-alive” notification.
- **Advanced power supply control** for electrical grids under certain determined particularities.
- Whether **saved scenes are kept after download** or the ones configured by parameters are loaded.

ETS PARAMETERISATION

After importing the corresponding database in ETS and adding the device into the topology of the desired project, the configuration process begins by entering the Parameters tab of the device.

Note: *once the device is in operation, it is advisable to switch off the loads prior to performing further parameter downloads from ETS.*

The tab tree on the left shows the “General” tab in the first place, containing the following parameters:

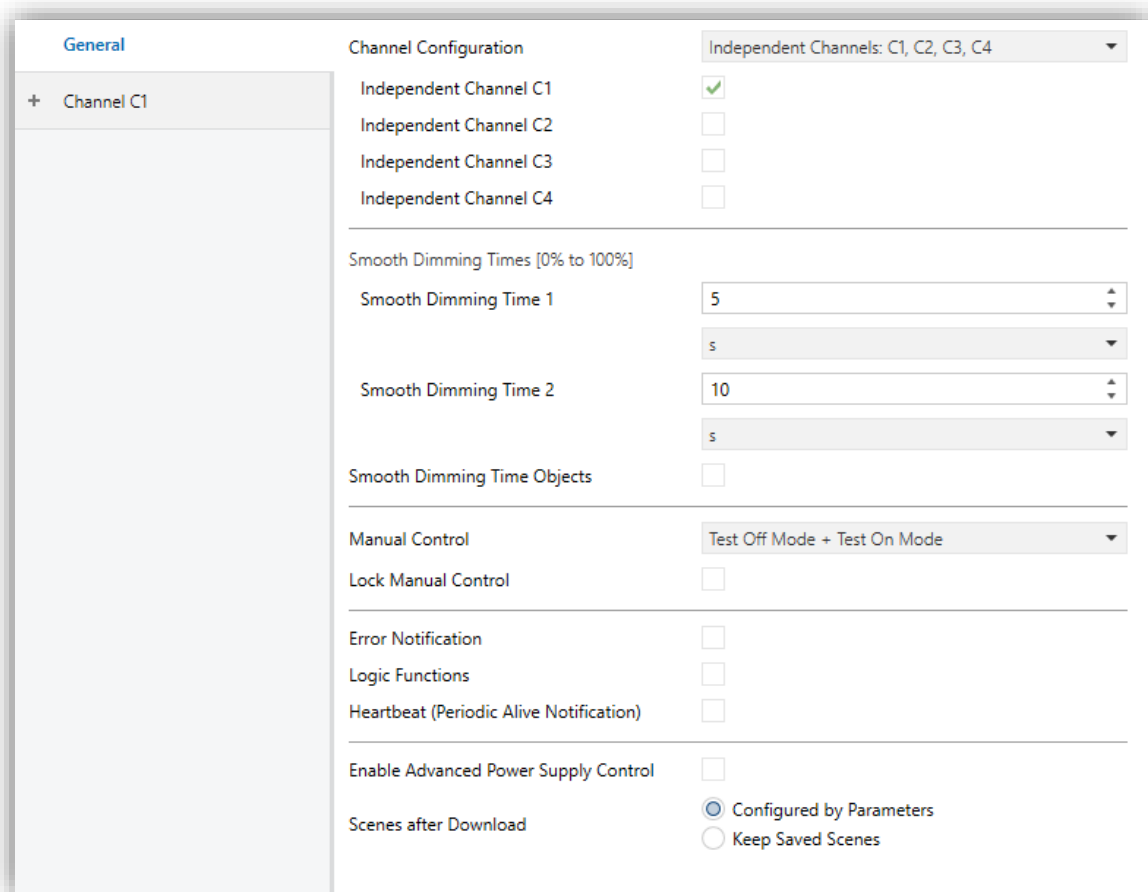

Figure 4 General - Configuration.

- **Channel Configuration:** sets which channels will be functional, and whether they should be controlled independently or jointly. There are several options.

- [\[Independent Channels: C1, C2, C3, C4\]](#)¹: all channels will be functional, and will be controllable separately. The parameterisation of this option depends on each device. When selected, four checkboxes will appear to enable each channel separately.
- [\[Common Channel: C1+C2+C3+C4\]](#): all channels will be functional, although they will be controlled jointly.
- [Channels by Blocks](#): this option allows set channels in blocks of two.

The options for each block are:

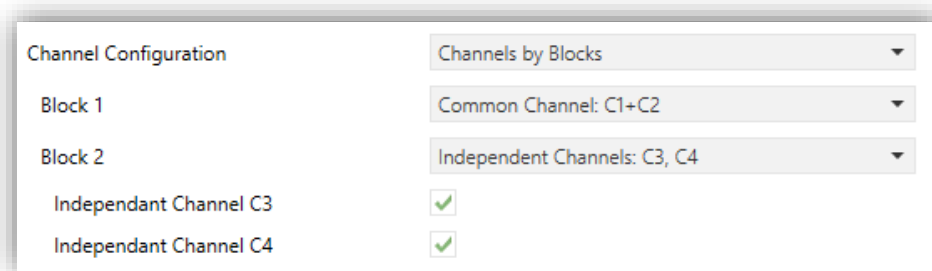

Figure 5 Channels by Blocks configuration in NarrowDIM X4.

- [\[Disabled\]](#): both channels are disabled.
- [\[Independent Channels: Cx, Cy\]](#): two checkboxes will appear to enable/disable each channel of the block individually.
- [\[Common Channel: Cx, Cy\]](#): both channels operate as a single channel.

Depending on the option selected and the channels enabled, different tabs are added to the left menu.

- **Smooth Dimming Times** [\[5...50\]\[ds\]](#) / [\[1...120\]\[s\]](#) / [\[1...5\]\[min\]](#). The longer the time, the smoother the light regulation.
- **Smooth Dimming Time Objects** [\[disabled/enabled\]](#): enables or disables the “Smooth Dimming Time 1” and “Smooth Dimming Time 2” two-byte objects, which allow re-defining in runtime the dimming times initially defined in parameters.

¹ The default values of each parameter will be highlighted in blue in this document, as follows: [\[default/rest of options\]](#).

- **Manual Control** [[Disabled](#) / [Test Off Mode + Test On Mode](#) / [Only with Test Off Mode](#) / [Only with Test On Mode](#)]: Please see section 2.5 for details.
- **Error Notification** [[disabled/enabled](#)]: enables or disables the “Error Notification” tab, which contains specific parameters for the case NarrowDIM X4 is required to report error events to the KNX bus. Please see section 2.3 for details.
- **Logic Functions** [[disabled/enabled](#)]: enables or disables the “Logic Functions” tab. Please see section 2.4 for details.
- **Heartbeat (Periodic Alive Notification)** [[disabled/enabled](#)]: this parameter lets the integrator incorporate a one-bit object to the project (“**[Heartbeat] Object to Send ‘1’**”) that will be sent periodically with a value of “1” to notify that the device is still working (still alive).

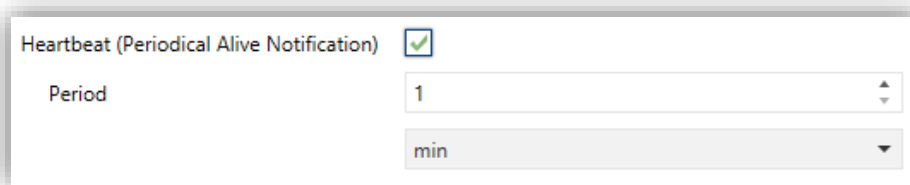

Heartbeat (Periodical Alive Notification)

Period 1

min

Figure 6 Heartbeat (Periodical Alive Notification)

Note: The first sending after download or bus failure takes place with a delay of up to 255 seconds, to prevent bus overload. The following sendings match the period set.

- **Enable Advanced Power Supply Control** [[disabled/enabled](#)]: enables or disables a software filter that palliates the effect produced by disturbances in electrical grids (for example, superimposed higher frequency signals to indicate tariff changes) when the charge is at 100%. This parameter is disabled by default in order to avoid undesirable effects on electrical grids not subject to these particularities.
- **Scenes after Download** [[Configured by Parameters](#) / [Keep Saved Scenes](#)]: determines whether, after ETS downloading, the saved scenes are kept or the ones set by parameter are loaded.

2.2 CHANNEL Cx / CHANNEL Cx + Cy / CHANNEL C1 + C2 + C3 + C4

Regardless of the channel configuration chosen (independent channels, common channel or block channels; see section 2.1), the configuration options for each channel or set of channels are the same and are detailed in the following sections.

2.2.1 DIMMING

Regarding the light dimming function, the following options are available for each channel:

- The **load type**, which should be RCL (conventional loads), CFL or LED. Different dimming patterns are applied for each case. Please see section 1.2 for details.

- In the case of a **conventional** load (RCL), the integrator will have the option to **manually** set the type (R, C or L) or to let NarrowDIM X4 perform an **automatic** detection.

Note: *if the integrator opts for manually setting a conventional load type (R, C or L) and then installs the wrong type, NarrowDIM X4 will notify the KNX installation about it. See section 2.3.*

- In the case of a **CFL** or a **LED** load, the integrator will have the option to select the dimming pattern (among three options) that best fits the load being regulated. Next, it is necessary to select the dimming mode, that is, whether to regulate the load on the trailing edges of the wave or on the leading edges. Some testing with these options is advisable in order to obtain the best results for the specific lamp being regulated.

Note: *if the device detects issues while trying to regulate the load, it will consider that the selected dimming mode is wrong for the current load, and notify the KNX bus about it. See section 2.3*

- The **type of response** (immediate or smooth, with two smooth speeds available for configuration at the integrator's disposal) of the different light controls: precise dimming (i.e., orders to set a specific light level, expressed in terms of percentage), relative dimming (i.e., orders to increase or decrease the current light level by a certain percentage) and switch-on / switch-off.

- The **load switch-on method**, being possible to configure whether the loads should always recover their previous light level (the one they had before being switched off; this is referred to as **memory function**) when a new switch-on order arrives, that it acquires their maximum level or that the switch-on value is defined by object. In case of selecting 'Previous' or 'Defined by object', the integrator may decide if a new switch-on overwrites the saved value and go to maximum or it is ignored, requiring a relative or precise order or a secondary on/off to achieve 100%.
- Whether to activate the **economical mode** (only for RCL loads), which consists in proportionally reducing the actual light level (and thus the energy consumption) by applying a certain coefficient (20% to 100%), without altering the light levels sent and received through the KNX bus (0% to 100%). The above coefficient does take into account for calculating the actual dimming times, so even if the light level has been reduced by a certain percentage, the time it takes to go from the minimum to the maximum will not be shortened – it will still be the parameterised time.
- The **lowest light level** permitted (0% to 50%), as certain loads may show flickering or behave improperly in particularly low levels. When NarrowDIM X4 receives a request to dim the load to a value greater than 0% but lower than the parameterised limit, it will apply the level parameterised as minimum.

ETS PARAMETERISATION

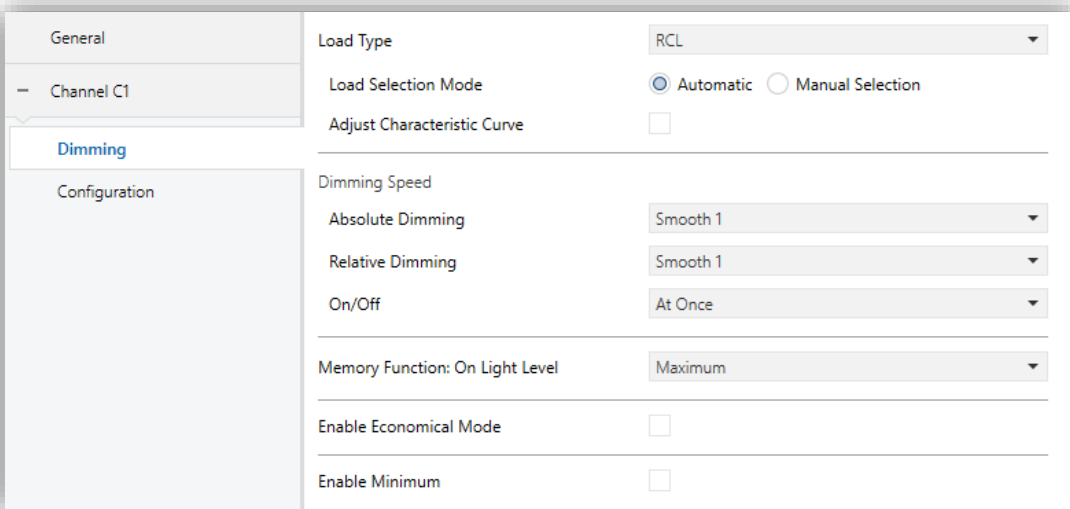

General	Load Type	RCL
Channel C1	Load Selection Mode	<input checked="" type="radio"/> Automatic <input type="radio"/> Manual Selection
Dimming	Adjust Characteristic Curve	<input type="checkbox"/>
Configuration	Dimming Speed	Smooth 1
	Absolute Dimming	Smooth 1
	Relative Dimming	Smooth 1
	On/Off	At Once
	Memory Function: On Light Level	Maximum
	Enable Economical Mode	<input type="checkbox"/>
	Enable Minimum	<input type="checkbox"/>

Figure 7 Channel Cx.

The “Dimming” screen of each channel contains the following parameters:

- **Load Type** [RCL (conventional lamps) / CFL / LED]: sets the type of the load that will be connected to the output channel. The following two parameters show up in case of selecting “RCL”:
 - **Load Selection Mode** [Automatic / Manual Selection]. In case of selecting “Manual Selection”:
 - **Type** [Resistive (R) / Capacitive (C/C+R) / Inductive (L/L+R)].

On the other hand, the following two parameters show up in case of selecting “CFL” or “LED”:

- **Dimming Pattern**: [Linear / Curve 1 / Curve 2]. Figure 8 shows the different regulation curves for each load type.

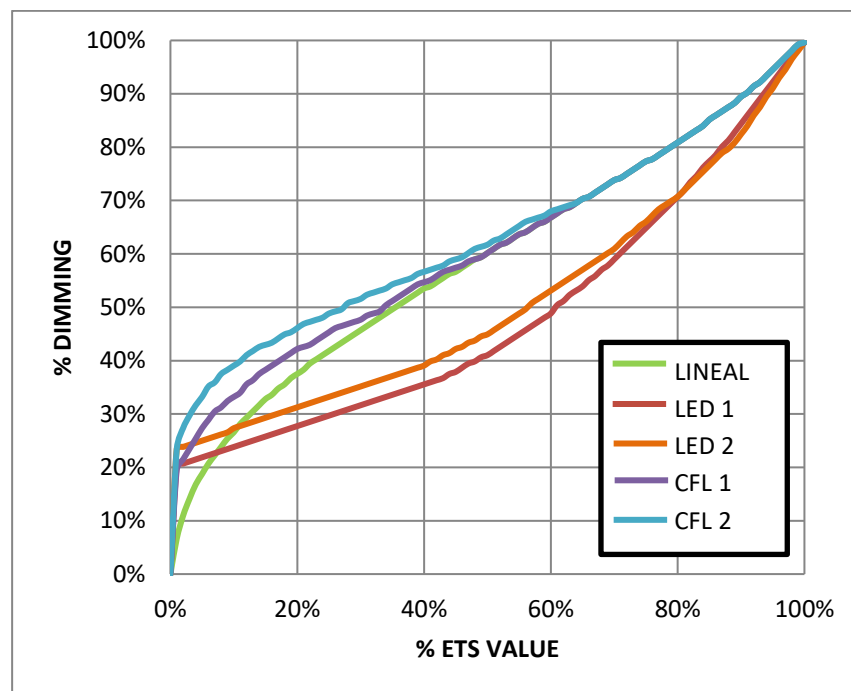

Figure 8 Dimming Patterns for LED and CFL loads.

- **Dimming Mode**: [Trailing Edge / Leading Edge].

Important: please configure these options with caution in order to obtain the best results. Refer to section 1.2 for details.

With independence of the load type, the following parameters will be shown:

- **Adjust Characteristic Curve** [[disabled](#) / [enabled](#)]: see section 2.2.1.1.
- **Dimming Speed**: sets the type of response (immediate or progressive; see section 2.1) for the different control orders.
 - **Absolute Dimming** [[At Once](#) / [Smooth 1](#) / [Smooth 2](#)].
 - **Relative Dimming** [[At Once](#) / [Smooth 1](#) / [Smooth 2](#)].
 - **On/Off** [[At Once](#) / [Smooth 1](#) / [Smooth 2](#)].
- **Memory Function: On Light Level**: sets the desired response for the switch-on orders of the object “[Cx] On/Off”:
 - [[Maximum](#)]: maximum light level; that is, a “memory” switch-on.
 - [[Previous](#)]: previous light level before last switch-off.
 - [[Defined by object](#)]: light level defined by the object “[Cx] Memory Function: Light Level”. After download, the object will be initialised to the maximum level.

If the option "[Previous](#)" or "[Object Defined](#)" is selected, the **Set Maximum after Second Order** [[disabled](#)/[enabled](#)] parameter will be displayed, which will enable the maximum light level at a new order.

- **Enable Economical Mode** [[Yes](#) / [No](#)]: enables (“[Yes](#)”) or disables (“[No](#)”) an internal reduction to the light level (and therefore the energy consumption) by a certain coefficient.
 - **Maximum Dimming Value** [[20...80...100](#)] [%]. The lower the maximum dimming value, the greater the consumption reduction.
- **Enable Minimum** [[Yes](#) / [No](#)]. In case of selecting “[Yes](#)”:
 - **Maximum Dimming Value** [[0...10...50](#)][%].

On the other hand, the following communication objects will be available:

- “[Cx] On/Off”: one-bit object for the reception of switch orders from the bus. One “1” will switch the light on, while one “0” will switch it off. The dimming speed will be “At Once”, “Smooth 1” or “Smooth 2” according to the parameters, as explained above.
- “[Cx] Absolute Dimming”: 1-byte object for the reception of the desired light level (in terms of percentage) from the bus. Once again, the dimming speed

will be “At Once”, “Smooth 1” or “Smooth 2” depending on the parameterisation, as explained above.

- “[Cx] Relative Dimming”: four-bit object for the reception of dimming orders from the bus. The value of the object will be interpreted as the desired step (brighter or darker), according to the KNX standard. The values “0” and “8” interrupt the current regulation.

Value	Response
0x0 (0)	Stop light dimming
0x1 (1)	Decrease the light level by 100%
0x2 (2)	Decrease the light level by 50%
0x3 (3)	Decrease the light level by 25%
0x4 (4)	Decrease the light level by 12%
0x5 (5)	Decrease the light level by 6%
0x6 (6)	Decrease the light level by 3%
0x7 (7)	Decrease the light level by 1%
0x8 (8)	Stop light dimming
0x9 (9)	Increase the light level by 100%
0xA (10)	Increase the light level by 50%
0xB (11)	Increase the light level by 25%
0xC (12)	Increase the light level by 12%
0xD (13)	Increase the light level by 6%
0xE (14)	Increase the light level by 3%
0xF (15)	Increase the light level by 1%

Table 1 Responses to the 4-bit Dimming Orders.

The dimming speed will be “At Once”, “Smooth 1” or “Smooth 2” depending on the parameterisation, as explained above.

- “Smooth Dimming Time 1” (provided that **Smooth Dimming Time Objects** has been enabled; see section 2.1): 1-byte object that allows the value of the “Smooth 1” control time to be changed in seconds via the bus. This modification will affect all actions where this time has been set. The time range of the objects to modify the regulation times (0 - 65535s) is greater than the maximum duration of these times (0.5 - 300s). So if a value longer than the maximum duration (300 seconds) is entered, this entry will be ignored. If a 0 is entered, the “At Once” speed (0.5s) will be adopted.

- “Smooth Dimming Time 2”: analogous to the above object, but for “Smooth 2”.

2.2.1.1 CHARACTERISTIC CURVE

Although NarrowDIM X4 provides several pre-set dimming patterns that should fit most luminaires, it is possible to define a custom dimming curve for each channel in order to get a specific response. This curve must be defined in terms of pairs of the form **{control value, dimming value}**, which set the responses required in the luminaire for particular control values.

The response for the intermediate control values is obtained by interpolation.

ETS PARAMETERISATION

General	Number of Value Pairs	2
Channel C1	Minimum Control	1 %
Dimming	Minimum Dimming	1 %
Characteristic Curve	Maximum Control	100 %
Configuration	Maximum Dimming	100 %

Figure 9 Characteristic Curve.

The “Characteristic Curve” screen, once enabled from the Dimming tab (see section 2.2.1), provides the following parameters:

- **Number of Value Pairs** [2 / 3 / 4]: sets how many pairs of values will define the curve.
- **Minimum Control**: sets the control value (as a percentage) of the first pair. This value is necessarily 1%.
- **Minimum Dimming** [1...99] [%]: sets the dimming value (as a percentage) of the first pair, i.e., the dimming level to be applied to the luminaire when the device receives a control value that matches the control value of the first pair.
- **Control 1** [2...50...99] [%] (only for three-point and four-point curves): sets the control value of the second pair.

- **Dimming 1** [2...50...99] [%] (only for three-point and four-point curves): sets the dimming value of the second pair.
- **Control 2** [2...75...99] [%] (only for four-point curves): sets the control value of the third pair.
- **Dimming 2** [2...75...99] [%] (only for four-point curves): sets the dimming value of the third pair.
- **Maximum Control**: sets the control value of the last pair. This value is necessarily 100%.
- **Minimum Dimming** [2...100] [%]: sets the dimming value of the last pair.

2.2.2 CONFIGURATION

In addition to the options already described regarding the light dimming function, NarrowDIM X4 offers some more additional features, which are disabled in parameters by default.

The next sections describe each of them: **status objects**, **custom On/Off** controls, **simple timer**, **flashing**, **scenes and sequences**, **alarm**, **channel lock by object**, **automatic switch-off** and **initialisation settings**.

ETS PARAMETERISATION

The “Configuration” screen allows enabling the following functions for each channel:

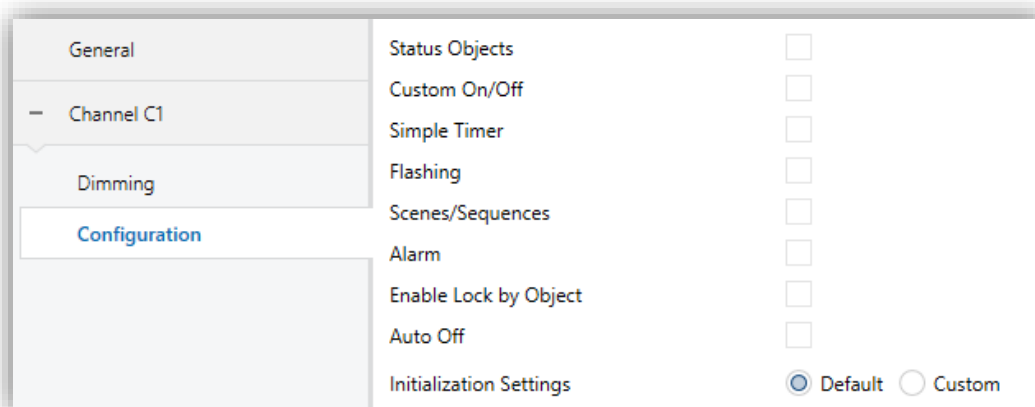

Figure 10 Configuration.

Marking any of the checkboxes will bring a **new entry to the tab tree** for the parameterisation of that particular function, with the exception of **Enable Lock By Object**, which has no parameters involved.

One drop-down box is also provided to select the desired **initialization** of the device [[Default](#) / [Custom](#)].

The next subsections describe each of the above functions.

2.2.2.1 STATUS OBJECTS

This function implements, for a particular channel, a one-bit On/Off status object and a one-byte (percentage) status object that will report the channel state at any time, thus informing other devices in the KNX installation.

ETS PARAMETERISATION

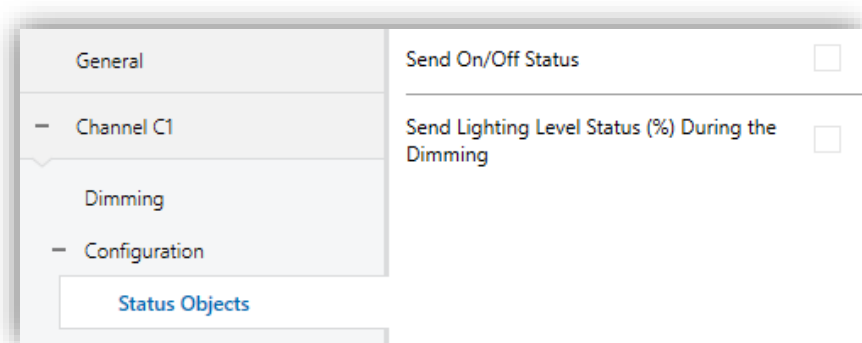

Figure 11 Status Objects.

This **Status Objects** screen contains the following parameters:

- **Send On/Off Status** [[disabled/enabled](#)]: enables the "[Cx] On/Off (Status)" one-bit object, which reports the On/Off state of the output channel when it changes. It is always automatically sent back to the bus after the reception of an On/Off order through the analogous control object.
- **Send Lighting Level Status (%) During the Dimming** [[disabled/enabled](#)]: enables the "[Cx] Lighting Level (Status)" one-byte communication object, which reports –whenever it changes– the status of the light level applied to the output channel in terms of percentage, with an accuracy of $\pm 1\%$. If enabled, the following parameter also shows up:

- **Sending Period (with Value Change)** [1...3...120] [s]: sets every how much time the status object should be sent to the bus during a progressive (smooth) dimming, provided that the value differs from the last sent.

In case a dimming order is received during either the lock state (see section 2.2.2.6), an alarm (see section 2.2.2.7) or an error situation (see section 2.3), these objects will be sent to the bus –provided that they have been enabled– with the same value they already had, to make it evident that the requested order has not been executed.

2.2.2.2 CUSTOM ON/OFF

This function brings the chance to enable up to two additional On/Off controls for the output channel, and therefore up to two new communication objects to switch the load on or off.

These additional controls allow customising the light level of the output for the “On” and “Off” states and the switch type (at once or smooth).

The custom On/Off function is particularly useful when the dimmer is required to set a specific light level for each room (children bedrooms, hospital rooms, etc.), other than the maximum light level of the normal On/Off control. In such cases, both functions (normal and custom On/Off) can coexist and be used depending on the situation.

ETS PARAMETERISATION

Once enabled, the “Custom On/Off” screen offers up to two additional On/Off controls for the channel. Both can be independently configured through the following parameters:

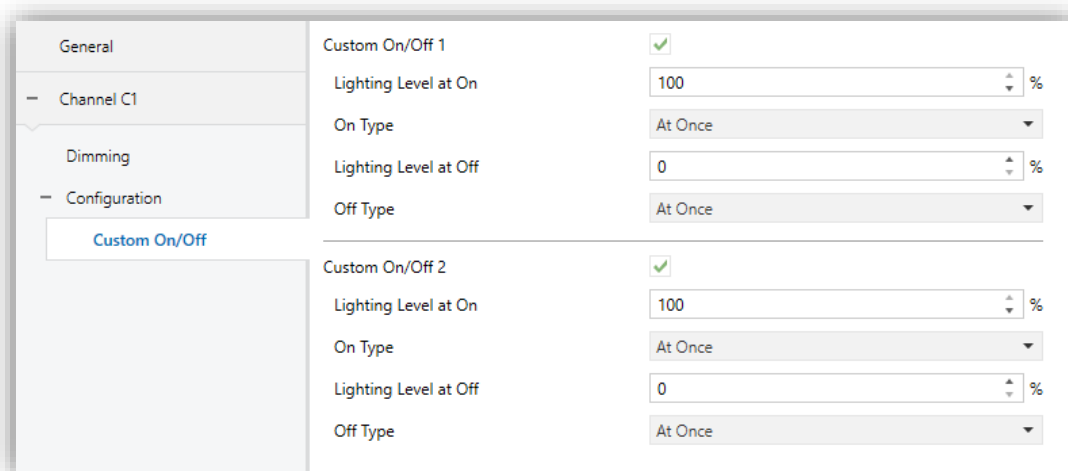

Figure 12 Custom On/Off.

- **Lighting Level at On** [*10...100*] [%]: sets the desired light percentage to be applied to the channel when the value "1" is received through the "[Cx] Custom On/Off Y" 1-bit communication object (being "Y" equal to 1 or 2).
- **On Type** [*At once / Smooth 1 / Smooth 2*]: sets the desired dimming type for the custom switch-on of the channel:
- **Lighting Level at Off** [*0...50*] [%]: sets the desired light percentage to be applied to the corresponding channel when the value "0" is received through the "[Cx] Custom On/Off Y" 1-bit communication object.
- **Off Type** [*At once / Smooth 1 / Smooth 2*]: sets the desired dimming type for the custom switch-off of the channel.

2.2.2.3 SIMPLE TIMER

This function allows performing a switch-on of the load connected to the channel of NarrowDIM X4 and a later, automatic (timed) switch-off, being also possible to add delays and to parameterise the time length, the luminosity level and the dimming type. It is also possible to configure the desired effect in case the switch-on trigger is received several times (retriggering).

The timed switch-off can also be triggered in advance through the corresponding object, before the time count ends.

This function is useful in a **motion-dependent light control**, or when the load needs to be switched on and then switched off automatically after a certain time.

ETS PARAMETERISATION

Once enabled, the following parameters can be configured from the "Simple Timer" tab:

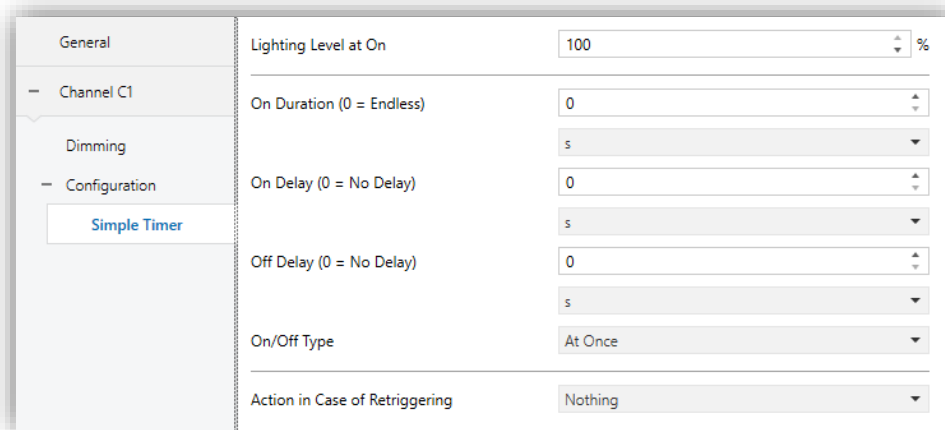

Figure 13 Simple Timer.

- **Lighting Level at On** [[10...100](#)] [%]: sets the desired light percentage to be applied when the timed switch-on is triggered (**[Cx] Simple Timer = 1**).
- **On Delay** [[\[0...3600\]\[s\]](#) / [\[0...1000\]\[min\]](#) / [\[0...100\]\[h\]](#)]: sets the time NarrowDIM X4 will wait since the reception of the timed switch-on order and the actual switch-on of the load. If no delay is needed, this field should remain at zero.
- **Off Delay**: analogous to the previous parameter, but for the timed switch-off orders (**[Cx] Simple Timer = 0**).
- **On Duration** [[\[0...3600\]\[s\]](#) / [\[0...1000\]\[min\]](#) / [\[0...100\]\[h\]](#)]: sets the time of the “On” stage before the load automatically switches off. A value of “0” in this field means that the load should remain on until a contrary order is received.

Note: *the time space defined here refers to the entire “On” stage, including (if applicable) the smooth dimming time. In case the dimming is too slow and the “On Duration” time too short, only a partial light transition will take place.*
- **On/Off Type** [[At Once](#) / [Smooth 1](#) / [Smooth 2](#)]: sets the dimming type to be applied during the timed switch-on and switch-off of the channel.
- **Action in case of Retriggering:**
 - [[Nothing](#)]: successive arrivals of the Timer On order will not reset the timer.

- **[Restart]**: if the output has already been switched on and the On Duration time is counting, the count will be restarted whenever another “1” is received through the “[Cx] Simple Timer” communication object.
- **[Multiply]**: if the output has already been switched on and the On Duration time is counting, then the actual duration will be “n” times the parameterised time, being “n” the number of times the value “1” is received through the “[Cx] Simple Timer” communication object.

The above parameter does not apply to the On and Off Delays:

- If the On (or Off) delay count is running, the timer will NOT be reset even if a new “1” (or “0”) is received through “[Cx] Simple Timer”.

During the simple timing, receiving any other order to regulate the load will interrupt the time count and make NarrowDIM X4 execute the new request.

2.2.2.4 FLASHING

This function allows running **On-Off** sequences with customisable lengths (and light levels) for the “On” and the “Off” stages. It is also possible to set the number of repetitions (up to 255, or otherwise endless), as well as the light level of the output after the last repetition (or when an order to interrupt the flashing is received).

The flashing sequence starts when NarrowDIM X4 receives a “1” through the flashing object and stops once it has executed all the configured repetitions (unless an endless sequence has been parameterised). It is possible to interrupt the flashing sequence at any time by sending one “0” to the flashing object. Sending any other control order (e.g., On/Off, scenes, etc.) will also interrupt it. Also, it is possible to send the device the order to re-start the flashing sequence during the execution.

ETS PARAMETERISATION

Once the function has been enabled, the following parameters can be configured from the “Flashing” screen:

General	Lighting Level at On	100	%
Channel C1	On Duration	2	
Dimming		s	
Configuration	Off Duration	2	
Flashing		s	
	Number of Repetitions (0 = Endless)	0	
	Final Lighting Level	0	%

Figure 14 Flashing.

- **Lighting Level at On** [10...100] [%]: sets the desired light percentage to be applied to the load during the “On” stages.
 - **On Duration** [1...2...3600][s] / [1...1000][min] / [1...24][h]: sets the length of the “On” stages.
 - **Off Duration**: analogous to the above parameter, but for the “Off” stages.
 - **Number of repetitions** [0...255]: number of times the On/Off cycle will repeat during the sequence. For endless flashing, please enter “0”; in such case the sequence will repeat until an order to interrupt it (or any other dimming order: On/Off, scenes, etc.) is received.
- Note:** *the sequence is triggered by writing the value “1” to object “[Cx] Flashing”, and interrupted by writing the value “0” to the same object.*
- **Final Lighting Level** [10...100] [%]: sets the desired light percentage after the last repetition or after the reception of the value “0” through “[Cx] Flashing”.

2.2.2.5 SCENES/SEQUENCES

This function allows defining up to ten scenes/sequences per channel, which consist in a specific light ambient or dimming sequence than can be triggered by sending the corresponding scene number to the device.

ETS PARAMETERISATION

Each of the ten scenes/sequences can be individually configured from the “Scenes/Sequences” screen.

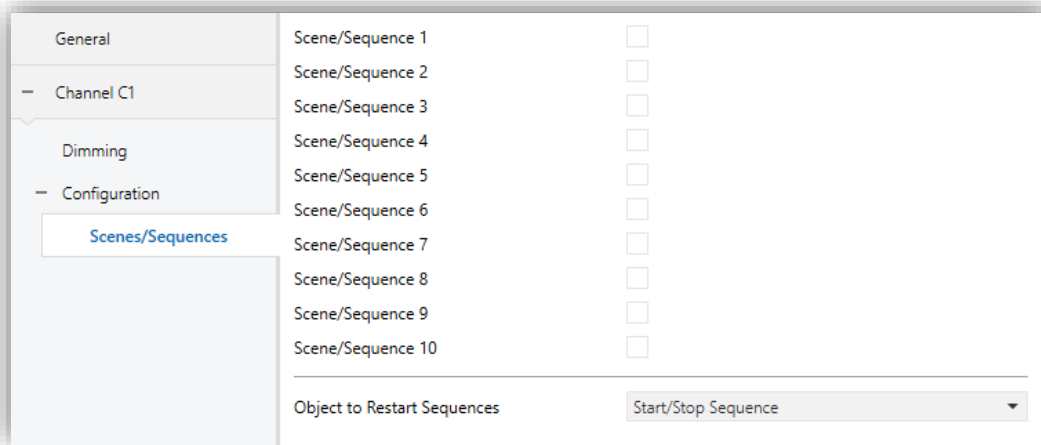

Figure 15 Scenes/Sequences.

One checkbox is shown for each of them. Marking any of these checkboxes brings a new entry to the tab tree, from which it is necessary to configure the following fields:

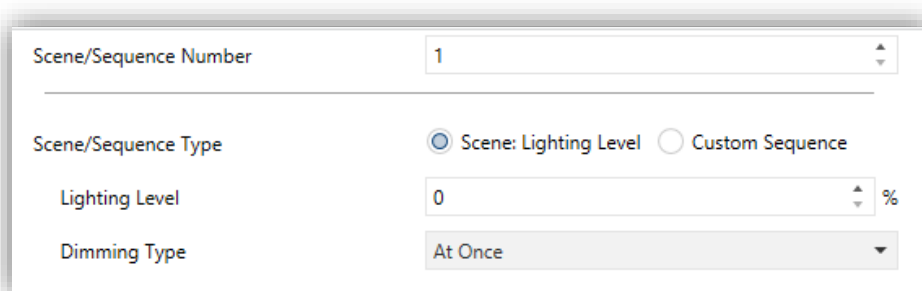

Figure 16 Scene.

- **Scene/Sequence number** [[1...64](#)]: sets the scene/sequence identifying number. The reception of this number (subtracting 1, according to the KNX standard) through the “[Cx] Scenes/Sequences” object will make the controller perform the corresponding actions.
- **Scene/Sequence type**: selects the desired type of response:
 - [[Scene: Lighting Level](#)]: The scene will consist in setting a certain light level when the “[Cx] Scenes/Sequences” object is received with the proper scene number.

- **Lighting Level** [0...100] [%]: brightness level to be applied in the scene.
 - **Dimming type** [At once / Smooth 1 / Smooth 2]: allows setting whether to apply the new level at once or progressively.
- [Custom sequence]. The response will consist in a customisable sequence of up to five steps/actions, defined through the following parameters:

Figure 17 Sequence.

- **Cyclic** [Yes / No]: “Yes” will define a cyclic sequence (after the last step, the sequence will start over), while “No” will define a non-cyclic sequence.
- **Next Scene/Sequence**: this parameter offers the possibility of triggering –after the last step of the sequence– another sequence.
- **Lighting Level Status Sending** [Send continuously / Send when sequence ends]: if set to “Send continuously”, the light level will be sent to the KNX bus through “[Cx] Lighting Level (Status)” during smooth dimming. If set to “Send when sequence ends”, the level will be sent to the bus once the last step of the sequence finishes, even if the sending of the status is enabled or not. In both cases, however, the Status Objects function should have been enabled (see section 2.2.2).

- For every **action** [[disabled/enabled](#)], the following parameters are required:
- **Lighting Value** [[Set New Value](#) / [Keep Previous Value](#)]: If you select "Set new value", when this action takes place during the execution of the sequence, the lighting of the load will be changed to the value selected in the next parameter:
 - **Lighting Level** [[0...100](#)][%]: sets the desired luminosity for the step.
 - **Duration** [[1...2...3600](#)][s] / [[1...1000](#)][min] / [[1...24](#)][h]: sets the time length of the step (i.e., the action time).

Note: *the time space defined here refers to the entire step action, including (if applicable) the smooth dimming time. In case the dimming is too slow and the step action time too short, only a partial light transition will take place.*

- **Dimming type** [[At once](#) / [Smooth 1](#) / [Smooth 2](#)]: sets the dimming type for the transition between the steps.

On the general tab scenes, the configuration of an **object to re-start the sequences** is possible:

- [None]: Sequence control object disabled.
- [[Star/Stop Sequence](#)]: An object named “[Cx] **Start/Stop Sequence**” is provided in case a sequence needs to be interrupted (value “0”) or re-started (value “1”). If the value “1” is received while no sequence was being run, the last sequence will be triggered again (or the first one parameterised, if no sequences have been executed before).
- [[Resume/Pause Sequence](#)]: An object named “[Cx] **Resume/Pause Sequence**” is provided in case a sequence needs to be interrupted (value “0”) or re-started (value “1”) the sequence from action in which it was paused. If the value “1” is received while no sequence was being run, the last sequence will be triggered again (or the first one parameterised, if no sequences have been executed before).

Note that these objects only apply to sequences, not to static scenes.

Besides running a scene, it is being also possible to save it: if the device receives an order to save the scene (values 128-191 through “[Cx] Scenes/Sequences”), the current luminosity level of the load (and the dimming speed) will be saved, but only if the value corresponds to any of the parameterised scenes (if not, the order will be ignored).

2.2.2.6 LOCK CHANNEL

This function permits locking the channel by sending a "1" through a specific one-bit communication object. From that moment, any action being executed by the channel will stop and the load will maintain the brightness value it currently has.

Dimming orders during the lock state will be ignored, while objects common to both channels not implying changes in their light levels will still respond.

NarrowDIM X4 will unlock the channel when the value "0" arrives through the lock object. The channel will still maintain the same luminosity level: any request received during the lock state will not be run by the channel after the unlock event.

After a power failure, the channel will maintain the lock state and the light level (the **initialization settings** will not apply in this case; see section 2.2.2.9).

Note that the **Auto Off** (section 2.2.2.8) function will not be available during the lock.

ETS PARAMETERISATION

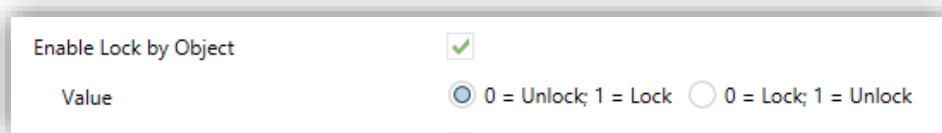

Figure 18 Bloqueo.

Enabling this function in the Configuration screen of the channel adds an object (“[Cx] **Lock**”) to the project topology.

According to the polarity of the selected **value**:

- [0 = Unlock; 1 = Lock], when this object receives the value “1” the channel will become locked, while the value “0” will resume the normal behaviour.

- [0 = Lock; 1 = Unlock], when this object receives the value “0” the channel will become locked, while the value “1” will resume the normal behaviour.

2.2.2.7 ALARMS

This function brings the possibility of configuring an **alarm action** over the output channel, which will be executed on the arrival of a specific trigger object from the bus. Moreover, the activation of the alarm will interrupt any timed action that may be in progress (simple timers, flashing and sequences).

The available alarm actions are: **stopping** the current regulation, **switching the load on** (at a specific, customisable value) and **switching the load off**.

It is possible to **cyclically monitor the alarm object**, and to configure the desired period time. If enabled, the alarm will not only be triggered through the arrival of the designated alarm value through the alarm object, but also in case the no-alarm value is not received at least once within the configured cycle time.

Regarding the **alarm deactivation**, the following actions are available: leaving the load **as is** (no change), **switching the load off**, **switching the load on** (at a specific, customisable value) and switching the load back to the **previous state**. This previous state corresponds to the final lighting level, i.e., the last one before the alarm activation (or the last target level, in case the alarm was triggered in the course of a regulation).

On the other hand, the deactivation can be either normal or frozen (i.e., through an acknowledgement):

- **Normal**: the device leaves the alarm state as soon as the no-alarm value is received.
- **Frozen**: after the arrival of the no-alarm value, an additional acknowledgement object must be received before the device leaves the alarm state.

Any light regulation orders received during the alarm state will be ignored.

After a device power failure, the channel will preserve the alarm state and the light level; any **initial settings** (see section 2.2.2.9) will not apply in this case.

Note that the **Auto Off** (section 2.2.2.8) function will not be available during the alarm.

ETS PARAMETERISATION

Figure 19 Alarm.

A specific alarm action can be configured per channel. Once this function has been enabled, the **Alarm** tab shows up:

The parameters involved in the **alarm activation** are:

- **Trigger** [0 / 1]: sets which value will imply the alarm activation when received through the “[Cx] Alarm” object, which will therefore imply the execution of the alarm activation action.
- **Cyclical Monitoring Period** [0...600] [ds] / [0...3600][s] / [0...1440][min] / [0...24][h]: sets the maximum time without receiving the no-alarm value that will be acceptable prior to automatically triggering the alarm. Value “0” disables the alarm cyclical monitor.
- **Action** [Stop / On / Off]: sets the desired response to the alarm activation. If the option “On” is selected, the parameter **Lighting Level** [0...100] [%] will set the desired switch-on level.

On the other hand, the parameters involved in the **alarm deactivation** are:

- **Mode** [Normal / Frozen (Acknowledgement Needed)]: sets the alarm deactivation procedure. When opting for the second option, object “[Cx] Unfreeze Alarm” will be included into the project topology for the reception of the acknowledgement messages (value “1”).

- **Action** [[No change](#) / [On](#) / [Off](#) / [Last \(Before Alarm\)](#)]: sets the desired response to the alarm deactivation. If the option “[On](#)” is selected, the parameter **Lighting Level** [[0...100](#)] [%] will set the desired switch-on level.

2.2.2.8 AUTO OFF

If the Auto Off function is enabled, the load controlled by the channel will automatically turn off after a certain time with a light level lower than a parameterisable limit.

The Auto Off function counts the time elapsed after the output falls below a certain threshold light level. If this count exceeds the parameterised timeout, NarrowDIM X4 will turn the load off. The count will stop if an order to increase back the light level over that limit is received.

ETS PARAMETERISATION

The only parameters contained by the “Auto Off” screen are:



Figure 20 Auto Off.

- **Lighting Level (Threshold)** [[5...50](#)] [%]: sets the desired light level that will trigger the time count.
- **Time** [[10...3600](#)][s] / [[1...1000](#)][min] / [[1...24](#)][h]: sets the time that should elapse before turning the channel off.

Notes:

- If the **Light Level (Threshold)** is lower than the **Lowest Light Level** (see section 2.2.1), the Auto Off will never be effective.

- It is recommended to take the regulation times into account when setting the auto off. If the dimming times are high, the luminaire may switch off before reaching the aimed dimming level.

Example: Having the following configuration:

- Smooth Dimming Time 2: 5 min
- Auto Off: Level: 5%, Time: 10s

If the luminaire is off (0%) and receives a dimming order with regulation time Smooth 2 to 100%, until 15 seconds have elapsed, the channel will not reach 5%; therefore, after 10 seconds, the auto off occurs without reaching the target regulation level.

2.2.2.9 INITIALISATION

This function is provided to let the integrator specify the desired load state after NarrowDIM X4 recovers from a KNX bus failure or a power supply failure.

In case the integrator feels comfortable with the **default** initialisation settings (load off after an ETS download, and previous light level after a bus or power supply recovery), it will not be necessary to configure this function.

ETS PARAMETERISATION

If **Initialisation Settings** (in the “Configuration” tab; see section 2.2.2) was set to “Custom”, a specific entry (“Initialisation Settings”) will be added to the tab tree. Otherwise, NarrowDIM X4 will implement the already described default load initialisation.

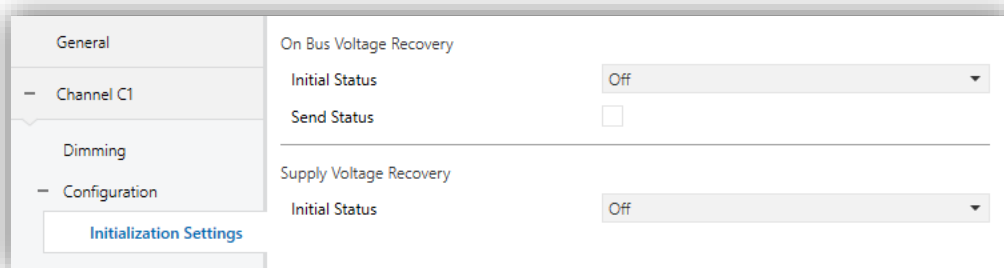

Figure 21 Initialization Settings.

From this new screen, it is possible to set the **Initial Status** [Off / On / Previous] of the load (both after a bus recovery or a power supply recovery). If the above is set to “On”,

then an additional parameter will show up (**Lighting Level** [0...100] [%]) to set the desired light level, in terms of percentage.

2.3 ERROR NOTIFICATIONS

2.3.1 BUS NOTIFICATIONS

Although NarrowDIM X4 permanently watches for error events and reacts to them to prevent damage in the loads and in the device itself, it can also notify the KNX bus about the occurrence of errors, if such option is set in parameters.

The error situations NarrowDIM X4 can report are: **short-circuits, overvoltage, overheat, anomalous network frequency, power supply failure** and **wrong load type** selection (in case of having parameterised an RCL load and having manually set a type –resistive, capacitive or inductive– that does not match that of the actual load).

2.3.2 LED INDICATORS

In addition to the above, NarrowDIM X4 always informs about errors by means of the on-board **LED indicators**. In case of concurrence of multiple errors, NarrowDIM X4 will only notify about the one with the highest priority – other errors with a lower priority (on whatever channel) will not be notified by the LEDs until the former is over. Nevertheless, if each channel is under a different error, the two of them will be notified through the LEDs, no matter which one has the highest priority.

Table 2 shows the error types in order of preference (see also the device **datasheet** for further details).

ERROR	LEDS DESCRIPTION	VISUAL NOTIFICATION	
Short circuit	The two LEDs of the channel with the error blink alternately each 0.25 second. When the output is locked, the programming LED blinks in blue.		
Voltage Surge	The two LEDs of the channel with the error blink simultaneously each 0.25 second. When the output is locked, the programming LED lights in blue.		+++
Overheating	The LEDs of all the channels blink each second.		-->
Supply Voltage Failure	One LED of each channel blinks each second.		PRIORITY
Anomalous Frequency	All the LEDs of each channel blinks (during 1 second) sequentially.		-->
Parameterization Error	One LED of the channel blinks each second while the other LED blinks each 0.25 second.		---

Table 2 Error Notification through the on-board LEDs.

2.3.3 REACTION TO ERRORS

For safety reasons and with independence of the bus notifications, NarrowDIM X4 always takes an action when an error is detected.

Note that when this action implies disconnecting the load, NarrowDIM X4 will no longer perform timed actions nor be aware of short-circuit, overvoltage or wrong load type situations, although other errors will still be monitored.

- In the case of multiple errors happening at the same time, NarrowDIM X4 will focus on the error with a higher priority (see Table 2), which is supposed to trigger a more restrictive response action.
- **Short Circuit:** when a short circuit takes place, NarrowDIM X4 disconnects the load and waits until a new dimming command is received. When that happens, it will simply try to dim the load and will repeat the process if a new short circuit is detected.

In case of more than **three short circuits in less than two minutes** time (without resetting the device), NarrowDIM X4 will remain **locked** for three minutes and ignore any dimming order addressed to that channel. The lock status will be notified to the KNX bus (if configured in parameters), and also by a blue intermittence of the Prog./Test LED.

- **Overvoltage:** when an overvoltage situation takes place, NarrowDIM X4 disconnects the load and waits until a new dimming command is received. When that happens, it will simply try to dim the load and will repeat the process if a new overvoltage is detected.

In case of more than **three overvoltages in less than two minutes** time (without resetting the device), NarrowDIM X4 will remain **locked** for three minutes and ignore any dimming order addressed to that channel. The lock status will be notified to the KNX bus (if configured in parameters), and also by leaving the Prog./Test LED turned on in blue colour.

- **Overheat:**
 - When the internal temperature of NarrowDIM X4 results to be **between 73°C and 75°C**, the device will lower the light level of the channels to 20%,

ignoring later orders to increase the level. Once the temperature is lower than **65°C** (73°C less an offset of 8°C), the device will resume the normal behaviour, although the light level will remain as is until a new dimming order is received.

- When the internal temperature results to be **over 75°C**, the device will completely disconnect both channels and switch the loads off, ignoring all orders to dim the light. When the temperature falls below **65°C** (75°C less an offset of 10°C), the device will resume the normal behaviour, although the light level will remain as is until a new order is received.
 - In addition to the above, NarrowDIM X4 is equipped with an **automatically resettable fuse**, which provides extra protection to the circuitry. Under situations of abnormally high temperature that cannot be solved by disconnecting the loads, this fuse will blow out, thus interrupting all communications and turning NarrowDIM X4 completely off.
- **Power Supply Failure:** when NarrowDIM X4 detects a drop of the power supply, it disconnects both channels and waits until it recovers. Whether the channels should remain off (or at a certain level) after the power recovery or recover their previous light levels can be parameterised (see section 2.2.2.9).
 - **Anomalous Frequency:** when NarrowDIM X4 detects an abnormal frequency in the power network, it will react analogously as for the Power Supply Failure. During the anomalous frequency error, the device will still be able to detect overheating and drops of the power supply.
 - **Wrong Load Type:** under either a non-conventional load type configuration or a manual configuration of a specific conventional (RCL) load type, in case NarrowDIM X4 tries to regulate the load and detects any issues due to a mismatch in the load type configuration, it will disconnect the output channel and wait for new dimming orders. When they arrive, it will try to dim the load and will repeat the process if the load type is still wrong.

ETS PARAMETERISATION

If error notifications have been enabled from the **General** tab (see section 2.1), an additional entry will be shown in the tab tree on the left.

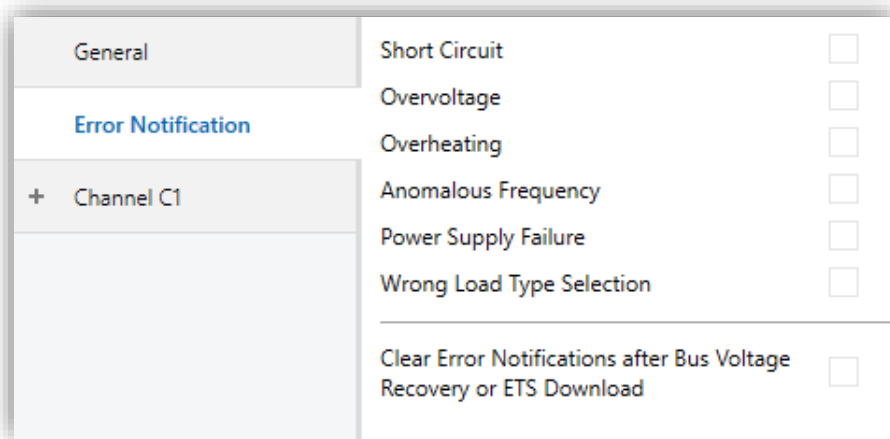

Figure 22 Error Notification.

This screen contains one checkbox per error situation (including **Wrong Load Type Selection**, in case of parameterising either a specific conventional load or a non-conventional load type). Marking any of them will add a specific one-bit communication object to the project topology (or two, if the error is channel-dependent but a two-channel control has been configured).

The specific error objects are:

- “Power Supply Fault”,
- “[Cx] Short Circuit”,
- “Overheating”,
- “[Cx] Overvoltage”,
- “Anomalous Frequency”.
- “[Cx] Load Type Parameterization Error”.

These objects are sent periodically sent to the bus (every thirty seconds) with a value of “1” as long as the error persists. Once the undesired situation is over, they are sent (once) with the value “0”. Note that, as already explained, if several errors take place at the same time, the error with the highest priority may mask other errors, which therefore will not be reported until the former is solved.

There is also a secondary object related to some of the error situations:

- “[Cx] Lock Due to Overvoltages”.

- “[Cx] Lock Due to Short Circuits”.

When NarrowDIM X4 gets automatically locked after detecting one of these errors multiple times, the lock object corresponding to that error will be sent with value “1”. Once the lock state is over, it will be sent with value “0”.

Back to the parameters, one more is shown in addition to the above checkboxes:

- **Clear Error Notifications after Bus Voltage Recovery or ETS Download**

[disabled/enabled]: sets whether the previous state of the enabled error objects should be cleared during the start-up of the device (i.e., whether they should be sent with the value “0” to the KNX bus).

This does not mean that NarrowDIM X4 will ignore any errors still taking place after the device start-up (in such case, the corresponding object will be sent with the value “1” after being sent with the value “0”), but may be useful to *force* all error states to zero in the beginning, to update other devices in the KNX installation.

2.4 LOGIC FUNCTIONS

This module makes it possible to perform numeric and binary operations to incoming values received from the KNX bus, and to send the results through other communication objects specifically enabled for this purpose.

NarrowDIM X4 can implement **up to 10 different and independent functions**, each of them entirely customisable and consisting in **up to 4 consecutive operations each**.

The execution of each function can depend on a configurable **condition**, which will be evaluated every time the function is **triggered** through specific, parameterisable communication objects. The result after executing the operations of the function can also be evaluated according to certain **conditions** and afterwards sent (or not) to the KNX bus, which can be done every time the function is executed, periodically or only when the result differs from the last one.

Please refer to the specific user manual “**Logic Functions**” (available in the NarrowDIM X4 product section at the Zennio homepage, www.zennio.com) for detailed information about the functionality and the configuration of the related parameter.

2.5 MANUAL CONTROL

The two output channels of NarrowDIM X4 can be manually operated and verified by means of the **on-board pushbuttons and LEDs** (two per channel), located on the top side of the device.

Two alternative approaches are provided for this manual control:

- **Test On Mode**, intended for testing the installation and the loads while setting up the device.
- **Test Off Mode**, intended for any other purposes during normal, long-term operation of the device.

ETS lets configuring **which of the two modes** (if not both) should be accessible. Moreover, a specific **object** can also be enabled in parameters in order to lock/unlock the manual control in runtime (to prevent undesired use, for example).

The **Test Off Mode is active any time** (unless disabled in parameters), which means that the on-board pushbuttons will work according to this mode by default.

On the other hand, **switching to the Test On Mode** (unless disabled in parameters) is done by holding the Prog/Test button for at least three seconds. This will turn the LED yellow. Once the button is released, the LED will become green (which means the Test On Mode is now active). Pressing the button again will turn the LED off, which will mean the Test Off Mode has become the active mode again

In case of having parameterised a two-channel joint control: CX +CY, only the pushbuttons of channel X will have effect (on both channels, in this case). Likewise, in case of having a single common channel: C1+C2+C3+C4, the manual control will be carried out using the pushbuttons of channel 1.

Note: *both manual control modes come enabled from factory.*

2.5.1 TEST ON MODE

Under this mode, the output channels will be controllable only by means of the manual control itself. Any orders received from the KNX bus will be ignored, and the status objects will not be sent to the bus either.

The error notification, lock and timed functions will remain inoperative as well. On the other hand, the **Economical mode** and the **Minimum Light Level** will still apply,

Note that, for safety reasons, the Test On Mode will not be accessible while there are errors in any of the channels (see section 2.3). On the other hand, if an error is detected during the Test On Mode, the device will automatically leave this mode.

Regarding the loads themselves, their reaction to the **short and long presses** will be as follows:

- **Short press:** the load will switch on or off, depending on the button.
- **Long press:** depending on the button, the load will keep progressively increasing or decreasing the light level until the button is released. The speed of this regulation will be the one that has been parameterised in ETS for the relative dimming.

2.5.2 TEST OFF MODE

Operating the manual control under this mode will be entirely analogous as receiving orders from the KNX bus. In fact, the device will still respond to any requests from the bus and will send the status objects when corresponding.

Under the Test Off Mode, the loads react to the **short and long presses** the same way they do in the Test On Mode:

- **Short press:** the load will switch on or off, depending on the button.
- **Long press:** depending on the button, the load will keep progressively increasing or decreasing the light level until the button is released. The speed of this regulation will be the one that has been parameterised in ETS for the relative dimming.

ANNEX I: COMMUNICATION OBJECTS

“Functional range” shows the values that, with independence of any other values permitted by the bus according to the object size, may be of any use or have a particular meaning because of the specifications or restrictions from both the KNX standard or the application program itself.

Number	Size	I/O	Flags	Data type (DPT)	Functional Range	Name	Function
1, 2	2 Bytes	I/O	C R W --	DPT_TimePeriodSec	0 - 65535	Smooth Dimming Time x	Time in Seconds
3	1 Bit	O	C R - T -	DPT_Alarm	0/1	Power Supply Failure	0 = No error; 1 = Error
4	1 Bit	O	C R - T -	DPT_Alarm	0/1	Overheating	0 = No error; 1 = Error
5	1 Bit	O	C R - T -	DPT_Alarm	0/1	Anomalous Frequency	0 = No error; 1 = Error
6	1 Bit	I/O	C R W --	DPT_Enable	0/1	Lock Manual Control	0 = Unlock; 1 = Lock
	1 Bit	I/O	C R W --	DPT_Enable	0/1	Lock Manual Control	0 = Lock; 1 = Unlock
7, 30, 53, 76	1 Bit	I	C - W --	DPT_Switch	0/1	[Cx] On/Off	0 = Off; 1 = On
7, 53	1 Bit	I	C - W --	DPT_Switch	0/1	[Cx+Cx] On/Off	0 = Off; 1 = On
7	1 Bit	I	C - W --	DPT_Switch	0/1	[Cx+Cx+Cx+Cx] On/Off	0 = Off; 1 = On
8, 31, 54, 77	1 Bit	O	C R - T -	DPT_Switch	0/1	[Cx] On/Off (Status)	0 = Off; 1 = On
8, 54	1 Bit	O	C R - T -	DPT_Switch	0/1	[Cx+Cx] On/Off (Status)	0 = Off; 1 = On
8	1 Bit	O	C R - T -	DPT_Switch	0/1	[Cx+Cx+Cx+Cx] On/Off (Status)	0 = Off; 1 = On
9, 32, 55, 78	4 Bit	I	C - W --	DPT_Control_Dimming	0x0 (Stop) 0x1 (Dec. by 100%) ... 0x7 (Dec. by 1%) 0x8 (Stop) 0xD (Inc. by 100%) ... 0xF (Inc. by 1%)	[Cx] Relative Dimming	4-bit dimmer control
9, 55	4 Bit	I	C - W --	DPT_Control_Dimming	0x0 (Stop) 0x1 (Dec. by 100%) ... 0x7 (Dec. by 1%) 0x8 (Stop) 0xD (Inc. by 100%) ... 0xF (Inc. by 1%)	[Cx+Cx] Relative Dimming	4-bit dimmer control
9	4 Bit	I	C - W --	DPT_Control_Dimming	0x0 (Stop) 0x1 (Dec. by 100%)	[Cx+Cx+Cx+Cx] Relative Dimming	4-bit dimmer control

					... 0x7 (Dec. by 1%) 0x8 (Stop) 0xD (Inc. by 100%) ... 0xF (Inc. by 1%)		
10, 33, 56, 79	1 Byte	I	C - W - -	DPT_Scaling	0% - 100%	[Cx] Absolute Dimming	1-byte dimmer control
10, 56	1 Byte	I	C - W - -	DPT_Scaling	0% - 100%	[Cx+Cx] Absolute Dimming	1-byte dimmer control
10	1 Byte	I	C - W - -	DPT_Scaling	0% - 100%	[Cx+Cx+Cx+Cx] Absolute Dimming	1-byte dimmer control
11, 34, 57, 80	1 Byte	O	C R - T -	DPT_Scaling	0% - 100%	[Cx] Lighting Level (Status)	0 - 100%
11, 57	1 Byte	O	C R - T -	DPT_Scaling	0% - 100%	[Cx+Cx] Lighting Level (Status)	0 - 100%
11	1 Byte	O	C R - T -	DPT_Scaling	0% - 100%	[Cx+Cx+Cx+Cx] Lighting Level (Status)	0 - 100%
12, 35, 58, 81	1 Byte	I	C - W - -	DPT_Scaling	0% - 100%	[Cx] Memory Function: Light Level	0 - 100%
12, 58	1 Byte	I	C - W - -	DPT_Scaling	0% - 100%	[Cx+Cx] Memory Function: Light Level	0 - 100%
12	1 Byte	I	C - W - -	DPT_Scaling	0% - 100%	[Cx+Cx+Cx+Cx] Memory Function: Light Level	0 - 100%
13, 36, 59, 82	1 Bit	I	C - W - -	DPT_Switch	0/1	[Cx] Custom On/Off 1	0 = Off; 1 = On
13, 59	1 Bit	I	C - W - -	DPT_Switch	0/1	[Cx+Cx] Custom On/Off 1	0 = Off; 1 = On
13	1 Bit	I	C - W - -	DPT_Switch	0/1	[Cx+Cx+Cx+Cx] Custom On/Off 1	0 = Off; 1 = On
14, 37, 60, 83	1 Bit	I	C - W - -	DPT_Switch	0/1	[Cx] Custom On/Off 2	0 = Off; 1 = On
14, 60	1 Bit	I	C - W - -	DPT_Switch	0/1	[Cx+Cx] Custom On/Off 2	0 = Off; 1 = On
14	1 Bit	I	C - W - -	DPT_Switch	0/1	[Cx+Cx+Cx+Cx] Custom On/Off 2	0 = Off; 1 = On
15, 38, 61, 84	1 Bit	I	C - W - -	DPT_Start	0/1	[Cx] Simple Timer	0 = Deactivate; 1 = Activate
15, 61	1 Bit	I	C - W - -	DPT_Start	0/1	[Cx+Cx] Simple Timer	0 = Deactivate; 1 = Activate
15	1 Bit	I	C - W - -	DPT_Start	0/1	[Cx+Cx+Cx+Cx] Simple Timer	0 = Deactivate; 1 = Activate
16, 39, 62, 85	1 Bit	I	C - W - -	DPT_Start	0/1	[Cx] Flashing	0 = Deactivate; 1 = Activate
16, 62	1 Bit	I	C - W - -	DPT_Start	0/1	[Cx+Cx] Flashing	0 = Deactivate; 1 = Activate
16	1 Bit	I	C - W - -	DPT_Start	0/1	[Cx+Cx+Cx+Cx] Flashing	0 = Deactivate; 1 = Activate
17, 40, 63, 86	1 Byte	I	C - W - -	DPT_SceneControl	0-63; 128-191	[Cx] Scenes/Sequences	Scene/Sequence value
17, 63	1 Byte	I	C - W - -	DPT_SceneControl	0-63; 128-191	[Cx+Cx] Scenes/Sequences	Scene/Sequence value
17	1 Byte	I	C - W - -	DPT_SceneControl	0-63; 128-191	[Cx+Cx+Cx+Cx] Scenes/Sequences	Scene/Sequence value
18, 41, 64, 87	1 Bit	I	C - W - -	DPT_Start	0/1	[Cx] Start/Stop Sequence	0 = Stop; 1 = Start
	1 Bit	I	C - W - -	DPT_Start	0/1	[Cx] Resume/Pause Sequence	0 = Pause; 1 = Resume
18, 64	1 Bit	I	C - W - -	DPT_Start	0/1	[Cx+Cx] Start/Stop Sequence	0 = Stop; 1 = Start
	1 Bit	I	C - W - -	DPT_Start	0/1	[Cx+Cx] Resume/Pause Sequence	0 = Pause; 1 = Resume
18	1 Bit	I	C - W - -	DPT_Start	0/1	[Cx+Cx+Cx+Cx] Start/Stop Sequence	0 = Stop; 1 = Start
	1 Bit	I	C - W - -	DPT_Start	0/1	[Cx+Cx+Cx+Cx] Resume/Pause Sequence	0 = Pause; 1 = Resume

19, 42, 65, 88	1 Bit	I/O	CRW--	DPT_Enable	0/1	[Cx] Lock	0 = Lock; 1 = Unlock
	1 Bit	I/O	CRW--	DPT_Enable	0/1	[Cx] Lock	0 = Unlock; 1 = Lock
19, 65	1 Bit	I/O	CRW--	DPT_Enable	0/1	[Cx+Cx] Lock	0 = Unlock; 1 = Lock
	1 Bit	I/O	CRW--	DPT_Enable	0/1	[Cx+Cx] Lock	0 = Lock; 1 = Unlock
19	1 Bit	I/O	CRW--	DPT_Enable	0/1	[Cx+Cx+Cx+Cx] Lock	0 = Unlock; 1 = Lock
	1 Bit	I/O	CRW--	DPT_Enable	0/1	[Cx+Cx+Cx+Cx] Lock	0 = Lock; 1 = Unlock
20, 43, 66, 89	1 Bit	I	C-W--	DPT_Alarm	0/1	[Cx] Alarm	0 = No Alarm; 1 = Alarm
	1 Bit	I	C-W--	DPT_Alarm	0/1	[Cx] Alarm	0 = Alarm; 1 = No Alarm
20, 66	1 Bit	I	C-W--	DPT_Alarm	0/1	[Cx+Cx] Alarm	0 = No Alarm; 1 = Alarm
	1 Bit	I	C-W--	DPT_Alarm	0/1	[Cx+Cx] Alarm	0 = Alarm; 1 = No Alarm
20	1 Bit	I	C-W--	DPT_Alarm	0/1	[Cx+Cx+Cx+Cx] Alarm	0 = Alarm; 1 = No Alarm
	1 Bit	I	C-W--	DPT_Alarm	0/1	[Cx+Cx+Cx+Cx] Alarm	0 = No Alarm; 1 = Alarm
21, 44, 67, 90	1 Bit	I	C-W--	DPT_Ack	0/1	[Cx] Unfreeze Alarm	Alarm = 0 + Unfreeze = 1 => End Alarm
	1 Bit	I	C-W--	DPT_Ack	0/1	[Cx] Unfreeze Alarm	Alarm = 1 + Unfreeze = 1 => End Alarm
21, 67	1 Bit	I	C-W--	DPT_Ack	0/1	[Cx+Cx] Unfreeze Alarm	Alarm = 0 + Unfreeze = 1 => End Alarm
	1 Bit	I	C-W--	DPT_Ack	0/1	[Cx+Cx] Unfreeze Alarm	Alarm = 1 + Unfreeze = 1 => End Alarm
21	1 Bit	I	C-W--	DPT_Ack	0/1	[Cx+Cx+Cx+Cx] Unfreeze Alarm	Alarm = 1 + Unfreeze = 1 => End Alarm
	1 Bit	I	C-W--	DPT_Ack	0/1	[Cx+Cx+Cx+Cx] Unfreeze Alarm	Alarm = 0 + Unfreeze = 1 => End Alarm
22, 45, 68, 91	1 Bit	O	CR-T-	DPT_Alarm	0/1	[Cx] Short Circuit	0 = No error; 1 = Error
22, 68	1 Bit	O	CR-T-	DPT_Alarm	0/1	[Cx+Cx] Short Circuit	0 = No error; 1 = Error
22	1 Bit	O	CR-T-	DPT_Alarm	0/1	[Cx+Cx+Cx+Cx] Short Circuit	0 = No error; 1 = Error
23, 46, 69, 92	1 Bit	O	CR-T-	DPT_Bool	0/1	[Cx] Lock Due to Short Circuits	0 = Unlocked; 1 = Locked
23, 69	1 Bit	O	CR-T-	DPT_Bool	0/1	[Cx+Cx] Lock Due to Short Circuits	0 = Unlocked; 1 = Locked
23	1 Bit	O	CR-T-	DPT_Bool	0/1	[Cx+Cx+Cx+Cx] Lock Due to Short Circuits	0 = Unlocked; 1 = Locked
24, 47, 70, 93	1 Bit	O	CR-T-	DPT_Alarm	0/1	[Cx] Overvoltage	0 = No error; 1 = Error
24, 70	1 Bit	O	CR-T-	DPT_Alarm	0/1	[Cx+Cx] Overvoltage	0 = No error; 1 = Error
24	1 Bit	O	CR-T-	DPT_Alarm	0/1	[Cx+Cx+Cx+Cx] Overvoltage	0 = No error; 1 = Error
25, 48, 71, 94	1 Bit	O	CR-T-	DPT_Bool	0/1	[Cx] Lock Due to Overvoltages	0 = Unlocked; 1 = Locked
25, 71	1 Bit	O	CR-T-	DPT_Bool	0/1	[Cx+Cx] Lock Due to Overvoltages	0 = Unlocked; 1 = Locked
25	1 Bit	O	CR-T-	DPT_Bool	0/1	[Cx+Cx+Cx+Cx] Lock Due to Overvoltages	0 = Unlocked; 1 = Locked

26, 49, 72, 95	1 Bit	O	CR-T-	DPT_Alarm	0/1	[Cx] Load Type Parameterization Error	0 = No error; 1 = Error
26, 72	1 Bit	O	CR-T-	DPT_Alarm	0/1	[Cx+Cx] Load Type Parameterization Error	0 = No error; 1 = Error
26	1 Bit	O	CR-T-	DPT_Alarm	0/1	[Cx+Cx+Cx+Cx] Load Type Parameterization Error	0 = No error; 1 = Error
99, 100, 101, 102, 103, 104, 105, 106, 107, 108, 109, 110, 111, 112, 113, 114, 115, 116, 117, 118, 119, 120, 121, 122, 123, 124, 125, 126, 127, 128, 129, 130	1 Bit	I	C-W--	DPT_Bool	0/1	[LF] (1-Bit) Data Entry x	Binary Data Entry (0/1)
131, 132, 133, 134, 135, 136, 137, 138, 139, 140, 141, 142, 143, 144, 145, 146	1 Byte	I	C-W--	DPT_Value_1_Ucount	0 - 255	[LF] (1-Byte) Data Entry x	1-Byte Data Entry (0-255)
147, 148, 149, 150, 151, 152, 153, 154, 155, 156, 157, 158, 159, 160, 161, 162	2 Bytes	I	C-W--	1.xxx	0/1	[LF] (2-Byte) Data Entry x	2-Byte Data Entry
163, 164, 165, 166, 167, 168, 169, 170	4 Bytes	I	C-W--	DPT_Value_4_Count	-2147483648 - 2147483647	[LF] (4-Byte) Data Entry x	4-Byte Data Entry
171, 172, 173, 174, 175, 176, 177, 178, 179, 180	1 Bit	O	CR-T-	DPT_Bool	0/1	[LF] Function x - Result	(1-Bit) Boolean
	1 Byte	O	CR-T-	DPT_Value_1_Ucount	0 - 255	[LF] Function x - Result	(1-Byte) Unsigned
	2 Bytes	O	CR-T-	DPT_Value_2_Ucount	0 - 65535	[LF] Function x - Result	(2-Byte) Unsigned
	4 Bytes	O	CR-T-	DPT_Value_4_Count	-2147483648 - 2147483647	[LF] Function x - Result	(4-Byte) Signed
	1 Byte	O	CR-T-	DPT_Scaling	0% - 100%	[LF] Function x - Result	(1-Byte) Percentage
	2 Bytes	O	CR-T-	DPT_Value_2_Count	-32768 - 32767	[LF] Function x - Result	(2-Byte) Signed
	2 Bytes	O	CR-T-	DPT_Value_Temp	-273.00° - 670433.28°	[LF] Function x - Result	(2-Byte) Float
181	1 Bit		C--T-	DPT_Trigger	0/1	[Heartbeat] Object to Send '1'	Sending of '1' Periodically



Join and send us your inquiries
about Zennio devices:

<http://support.zennio.com>

Zennio Avance y Tecnología S.L.
C/ Río Jarama, 132. Nave P-8.11
45007 Toledo (Spain).

Tel. +34 925 232 002.

www.zennio.com
info@zennio.com



RoHS